

TAN-5550

AEP Model

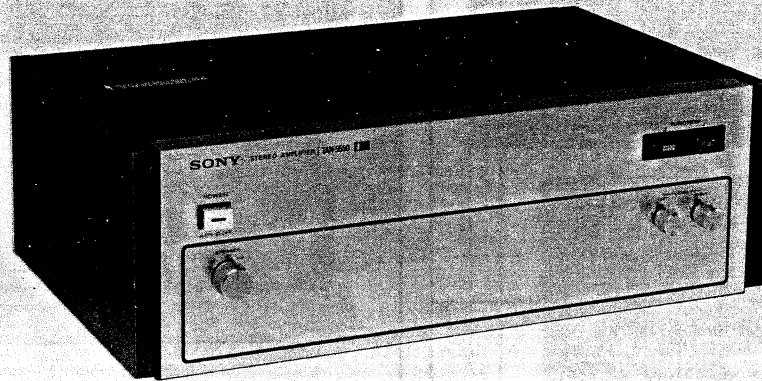

STEREO POWER AMPLIFIER

SPECIFICATIONS

POWER AMPLIFIER SECTION

Continuous RMS

Power Output: Both channels driven simultaneously
(rated output)
(Less than 0.1 % harmonic distortion)
At 20 ~ 20,000 Hz
50 + 50 W (8 Ω)
At 1 kHz
60 + 60 W (8 Ω)
50 + 50 W (4 Ω)
According to DIN 45500
60 + 60 W (8 Ω)

Dynamic Power Output: 160 W (8 Ω)
(IHF constant power supply method)
140 W (4 Ω)

Power Bandwidth: 5 ~ 40,000 Hz, IHF

Damping Factor: 100 (8 Ω , at 1 kHz)

Harmonic Distortion: Less than 0.1 % at rated output
Less than 0.08 % at 1 W output

IM Distortion: Less than 0.1 % at rated output
(60 Hz : 7 kHz = 4 : 1) Less than 0.08 % at 1 W output

Frequency Response: 10 ~ 100,000 Hz $^{+0}_{-2}$ dB
(NORMAL/TEST switches at NORMAL)
DC ~ 100,000 Hz $^{+0}_{-2}$ dB
(NORMAL/TEST switches at TEST)

S/N Ratio: Greater than 110 dB, short-circuited input

Residual Noise: Less than 0.02 μ W (8 Ω)

Inputs: Sensitivity 1.0 V (for rated output)
Impedance 50 k Ω

Outputs: SPEAKER A, B terminals
Accept 4 ~ 16 Ω speakers

GENERAL

Circuits: Phase-linear dc stereo power amplifier in direct-coupled V-FET pure complementary symmetry circuitry

Power Requirements: 110, 127, 220 or 240 V ac,
50/60 Hz

Power Consumption: 680 W

AC Outlet: 1 unswitched, 400 W

Dimensions: Approx.
460 (w) x 168 (h) x 305 (d) mm
18 $\frac{1}{8}$ (w) x 6 $\frac{5}{8}$ (h) x 12 $\frac{1}{8}$ (d) inches
Including projecting parts and controls

Weight: Approx. 12.5 kg, 27 lb 9 oz (net)
Approx. 14.9 kg, 32 lb 16 oz
(with shipping carton)

SONY®

SERVICE MANUAL

SECTION 1 OUTLINE

1-1. BLOCK DIAGRAM

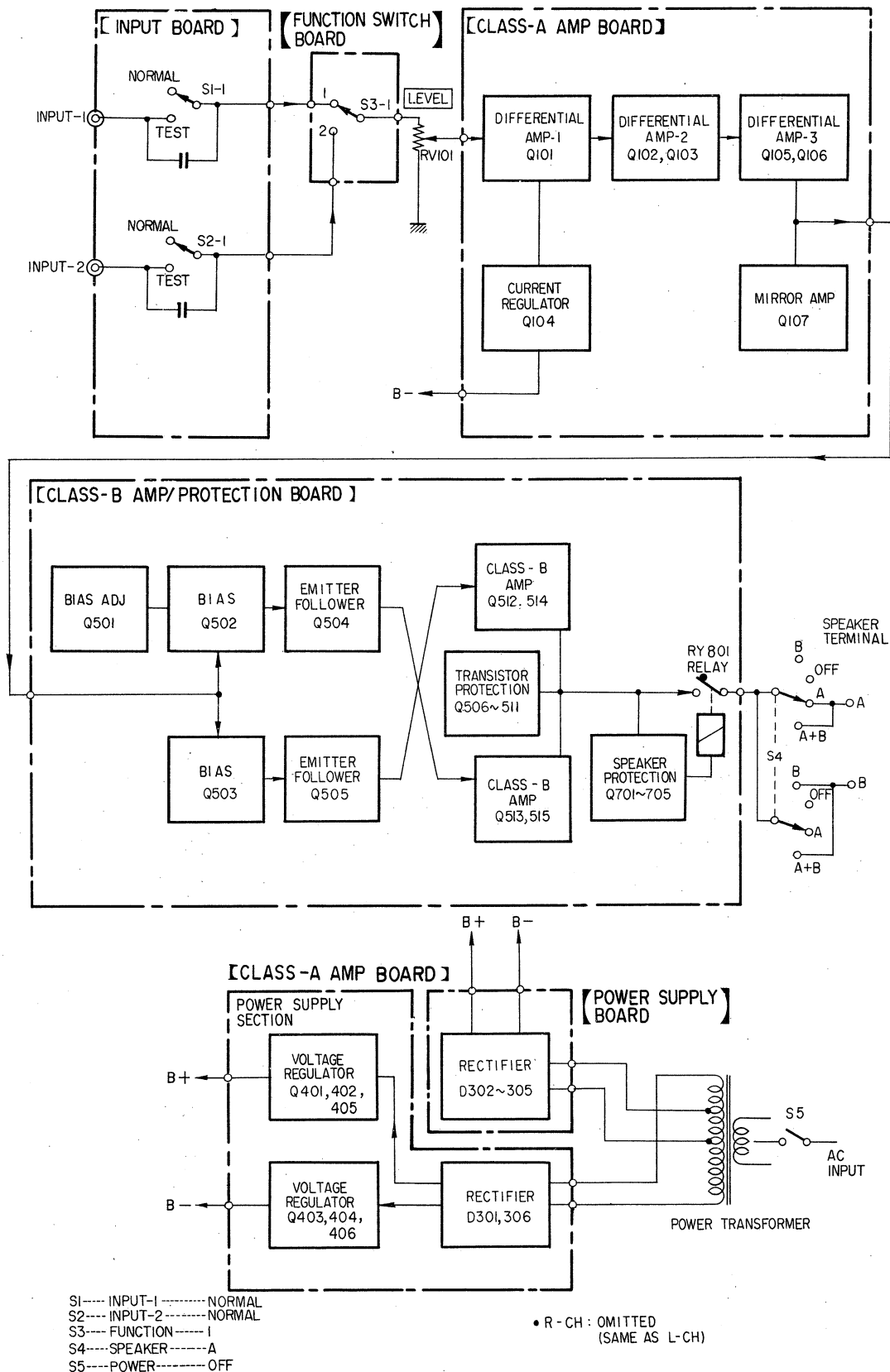

1-2. DISASSEMBLY

Front Panel Removal

Remove ① and ② .

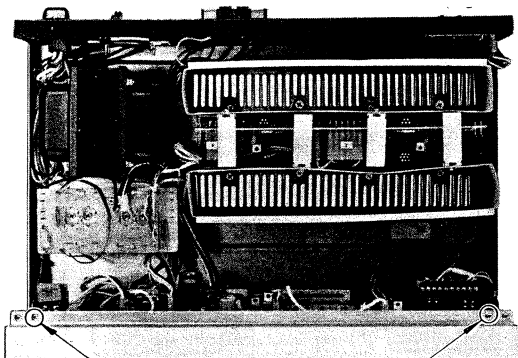

① B 3 x 8, self-tapping (two)

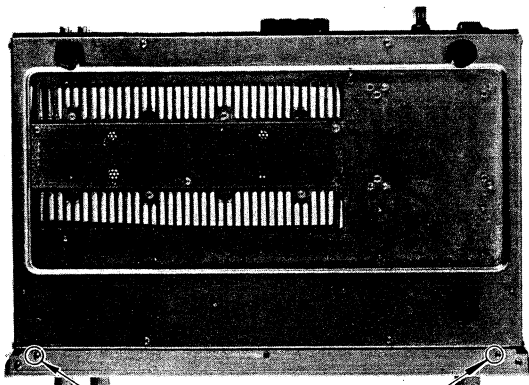

② B 3 x 8, self-tapping (two)

Front Sub-panel Removal

Remove ③ and ④ .

Rear Panel Removal

Remove ⑤ and ⑥ .

⑤ rear panel B 3 x 6, self-tapping (two)

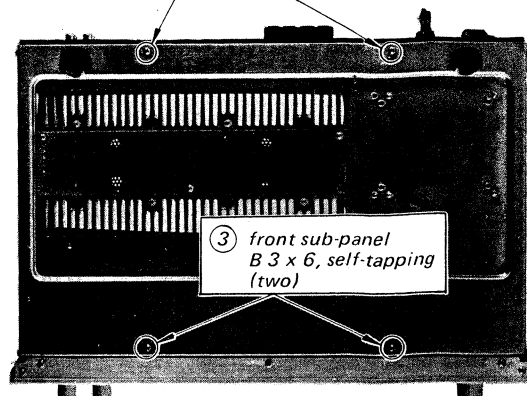

③ front sub-panel B 3 x 6, self-tapping (two)

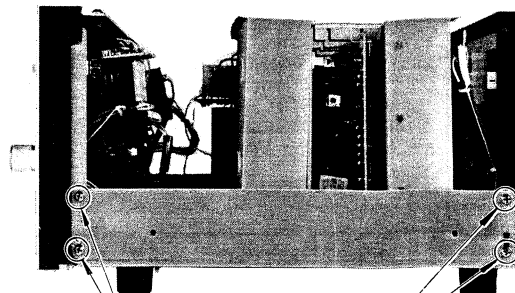

④ front sub-panel B 3 x 8, self-tapping (four)

⑥ rear panel B 3 x 8, self-tapping (four)



Input Board Removal

1. Remove screws on slide switches.
2. Remove nylon rivets with 4-P pin jack.

Class-A Amp Board Removal

Remove ⑦ .

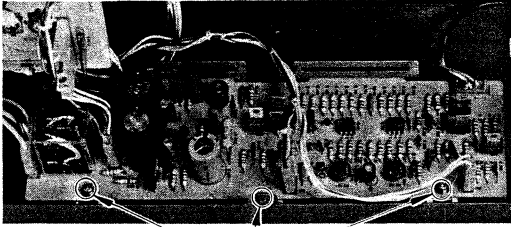

⑦ class-A amp board
B 3 x 6 (three)

Class-B Amp/Protection Board Removal

1. Remove ⑧ and heat sink duct.
2. Remove ⑨ and heat sink with class-B amp/ protection board.

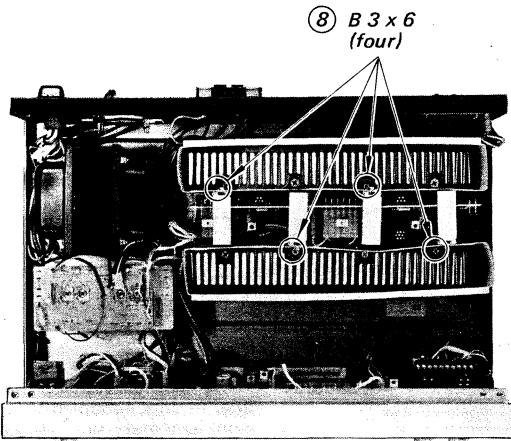

⑧ B 3 x 6
(four)

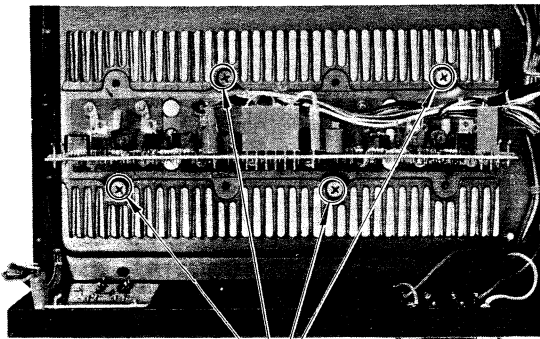

⑨ heat sink
B 4 x 8
(four)

Power Supply Board Removal

Remove ⑩ .

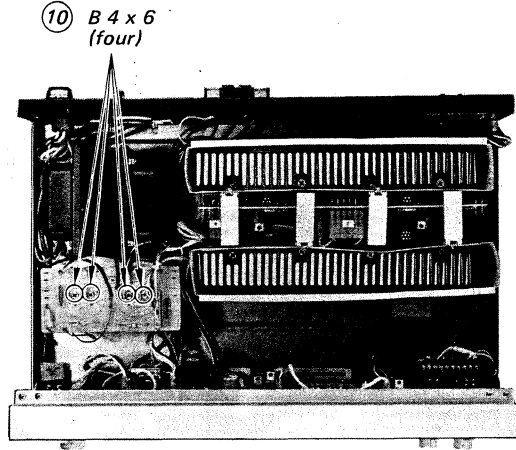

⑩ B 4 x 6
(four)

V-FET Replacement

1. Remove ⑪ and chassis.
2. Remove V-FET.

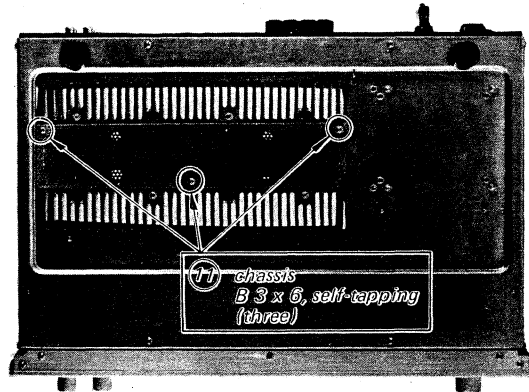

⑪ chassis
B 3 x 6, self-tapping
(three)

CAUTION

When replacing V-FET, use V-FET of same rank as shown below.

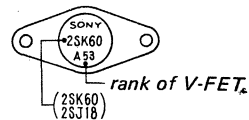

SECTION 3
DIAGRAMS

3-1. MOUNTING DIAGRAM — Input Board and Function Switch Board —
— Conductor Side —

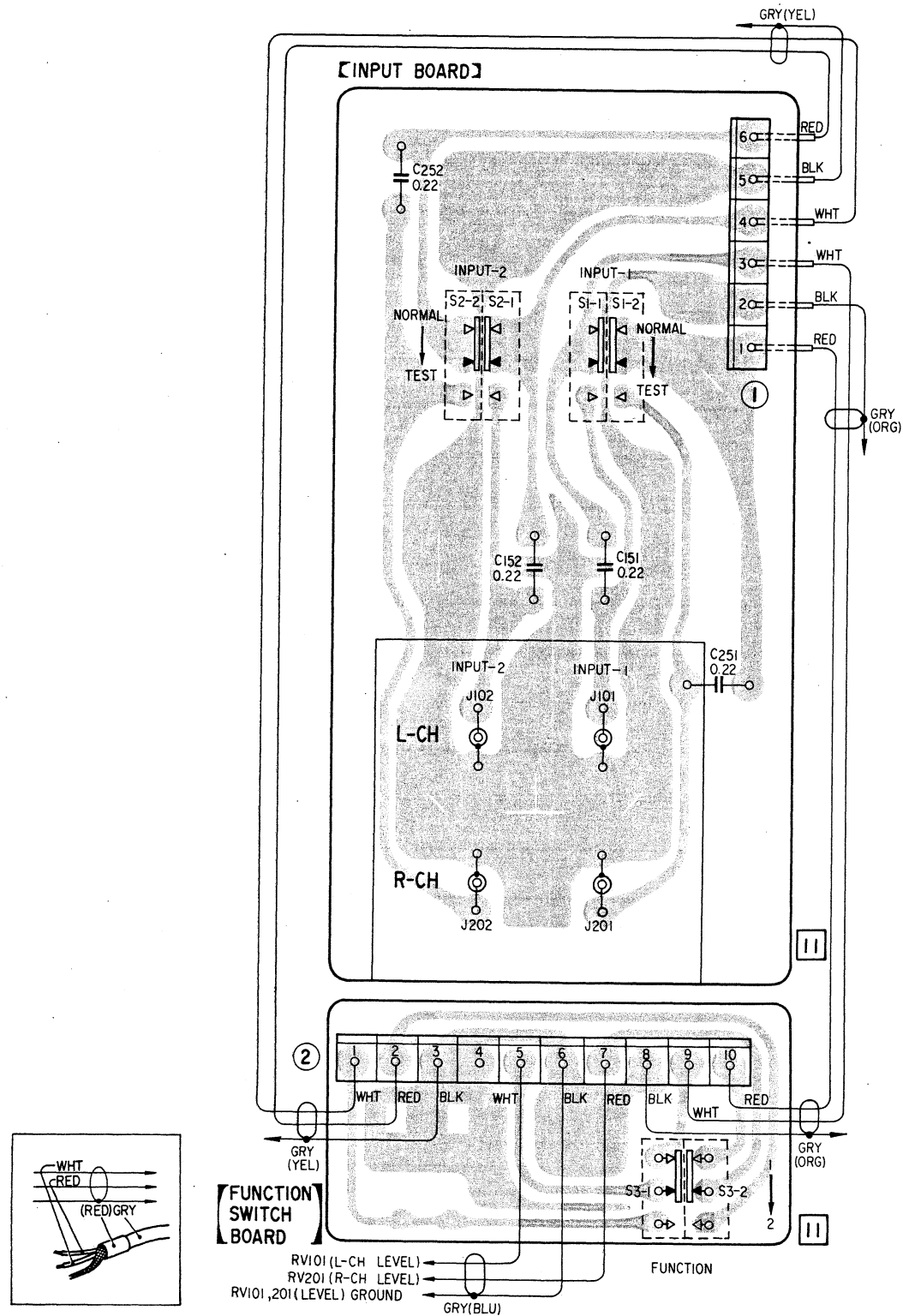

3-2. MOUNTING DIAGRAM — Power Supply Board —
— Conductor Side —

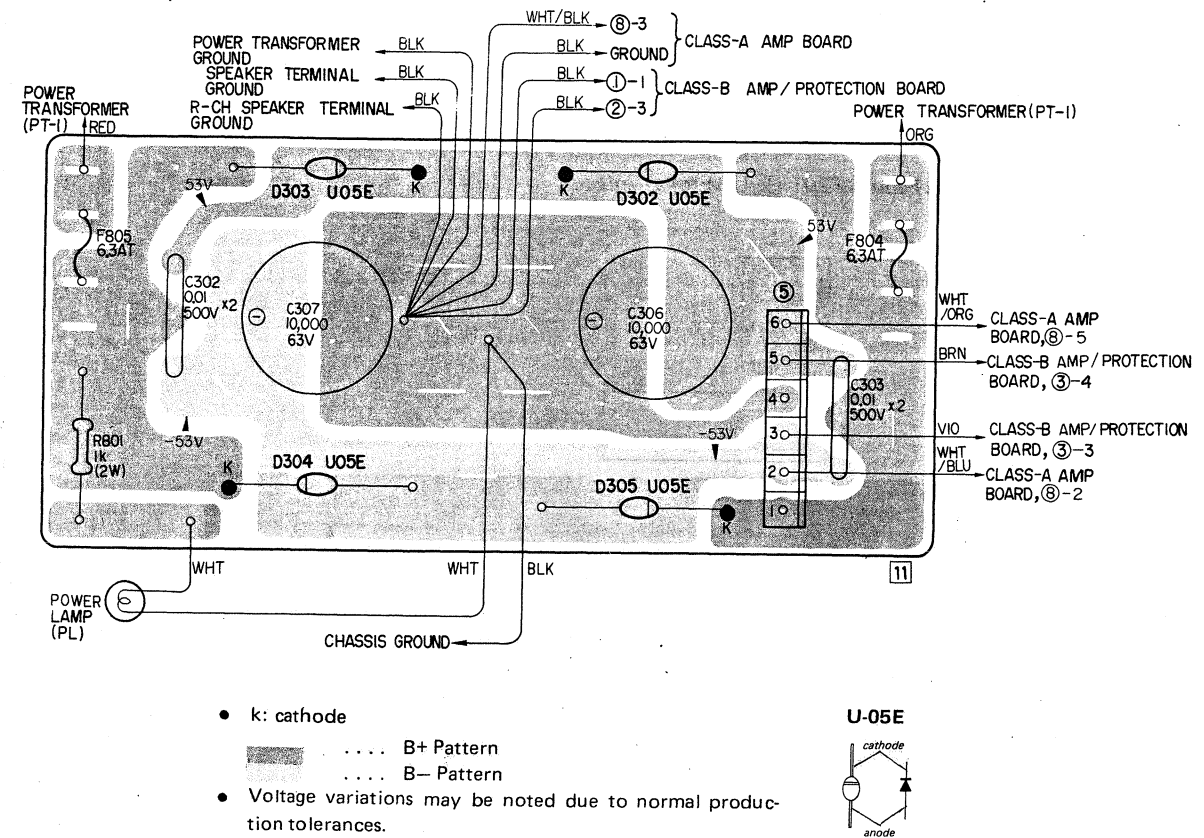

3-3. MOUNTING DIAGRAM — Fuse Board —
— Conductor Side —

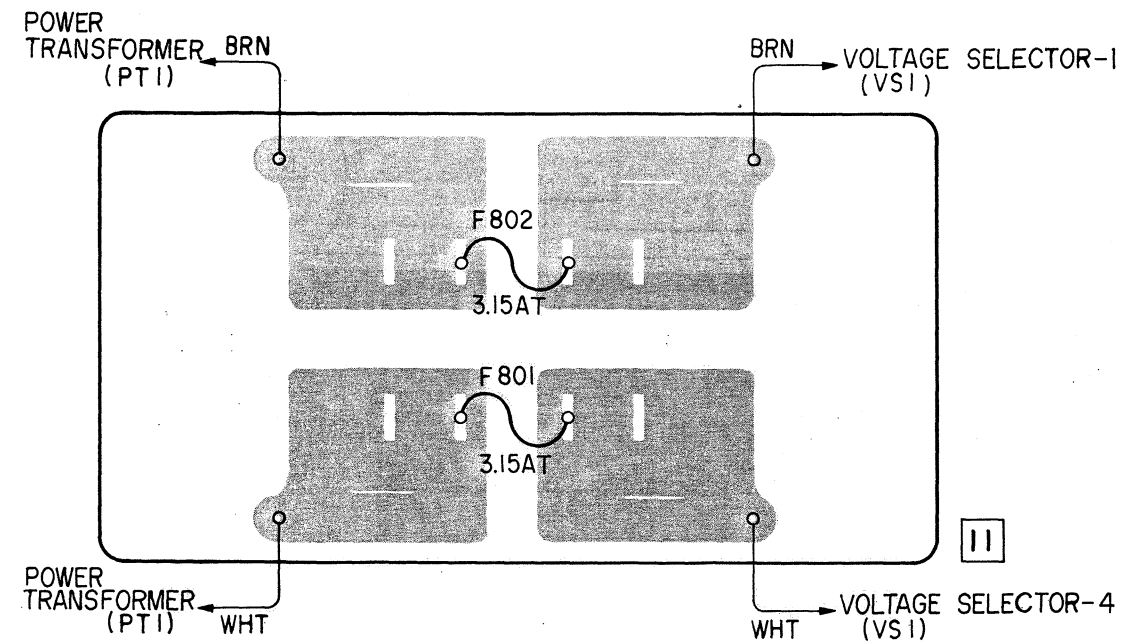

TAN-5550 TAN-5550

3.4. MOUNTING DIAGRAM – Class-A Amp Board – – Conductor Side –

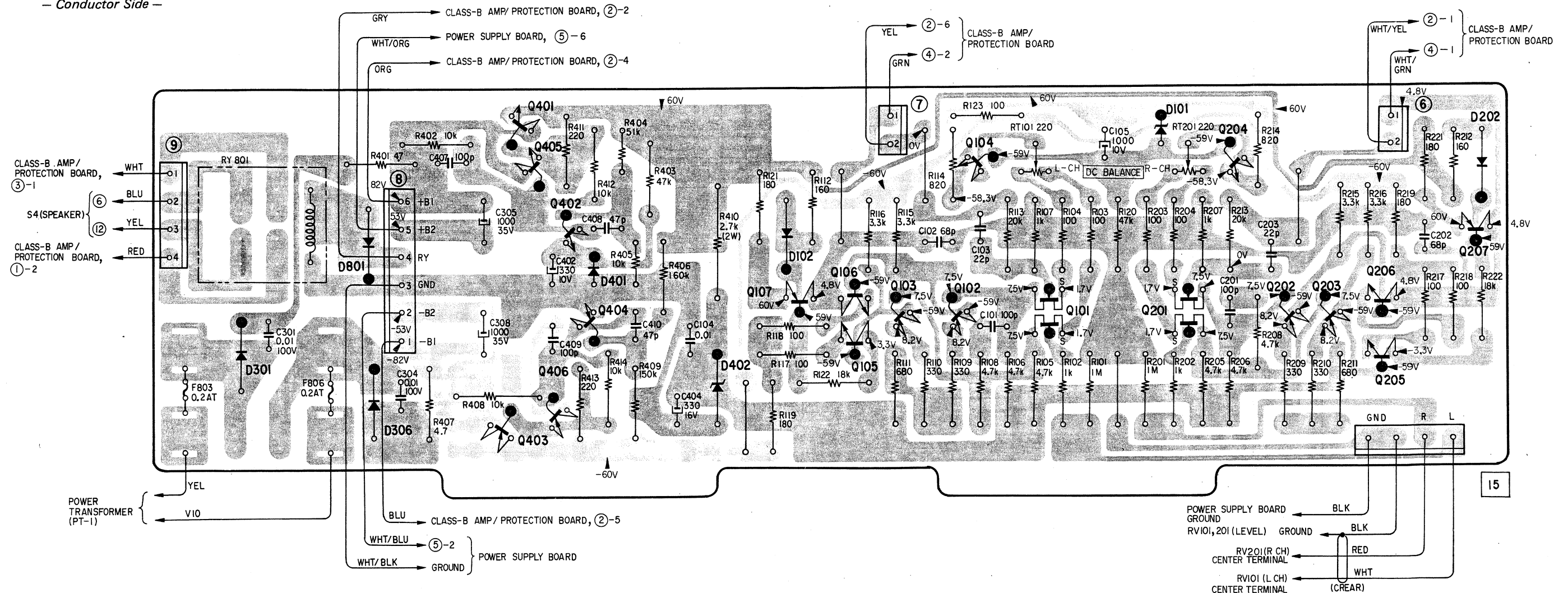

Q		401	405	402	404		107	106	103	104	101		201	204	202	203	206	207
		403	406	404				105		102							205	
D	301	801	306	401		402	102					101						202

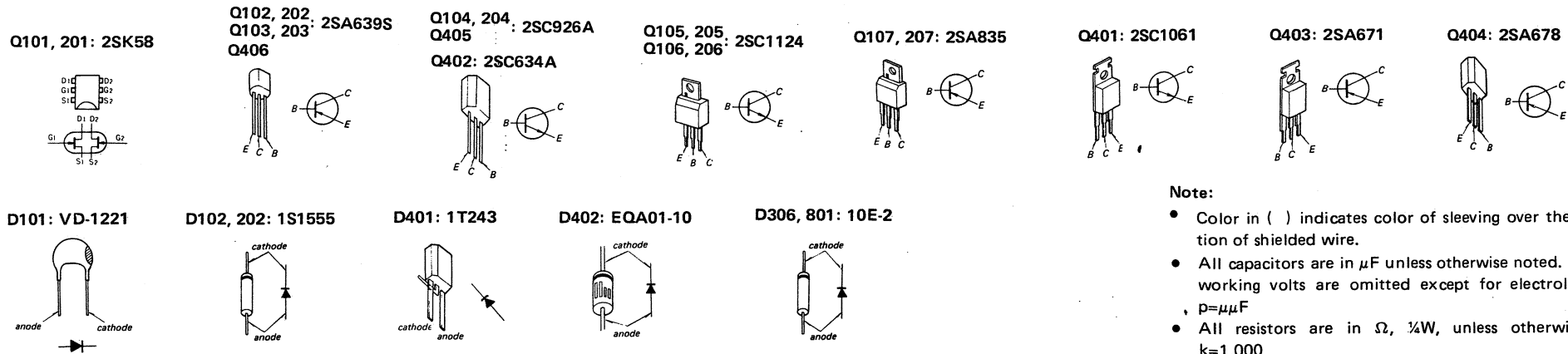

Note:

- Color in () indicates color of sleeving over the end portion of shielded wire.
- All capacitors are in μF unless otherwise noted. 50 or less working volts are omitted except for electrolytic type.
- $p = \mu\mu\text{F}$
- All resistors are in Ω , $\frac{1}{2}\text{W}$, unless otherwise noted. $k=1,000$

- Voltages are DC with respect to ground unless otherwise noted. Readings are taken under no-signal conditions with a VOM (20 $k\Omega/V$).
- B+ Pattern
- B- Pattern
- Voltage variations may be noted due to normal production tolerances.

TAN-550 TAN-5550

3-5. MOUNTING DIAGRAM – Class-B Amp/Protection Board – – Conductor Side –

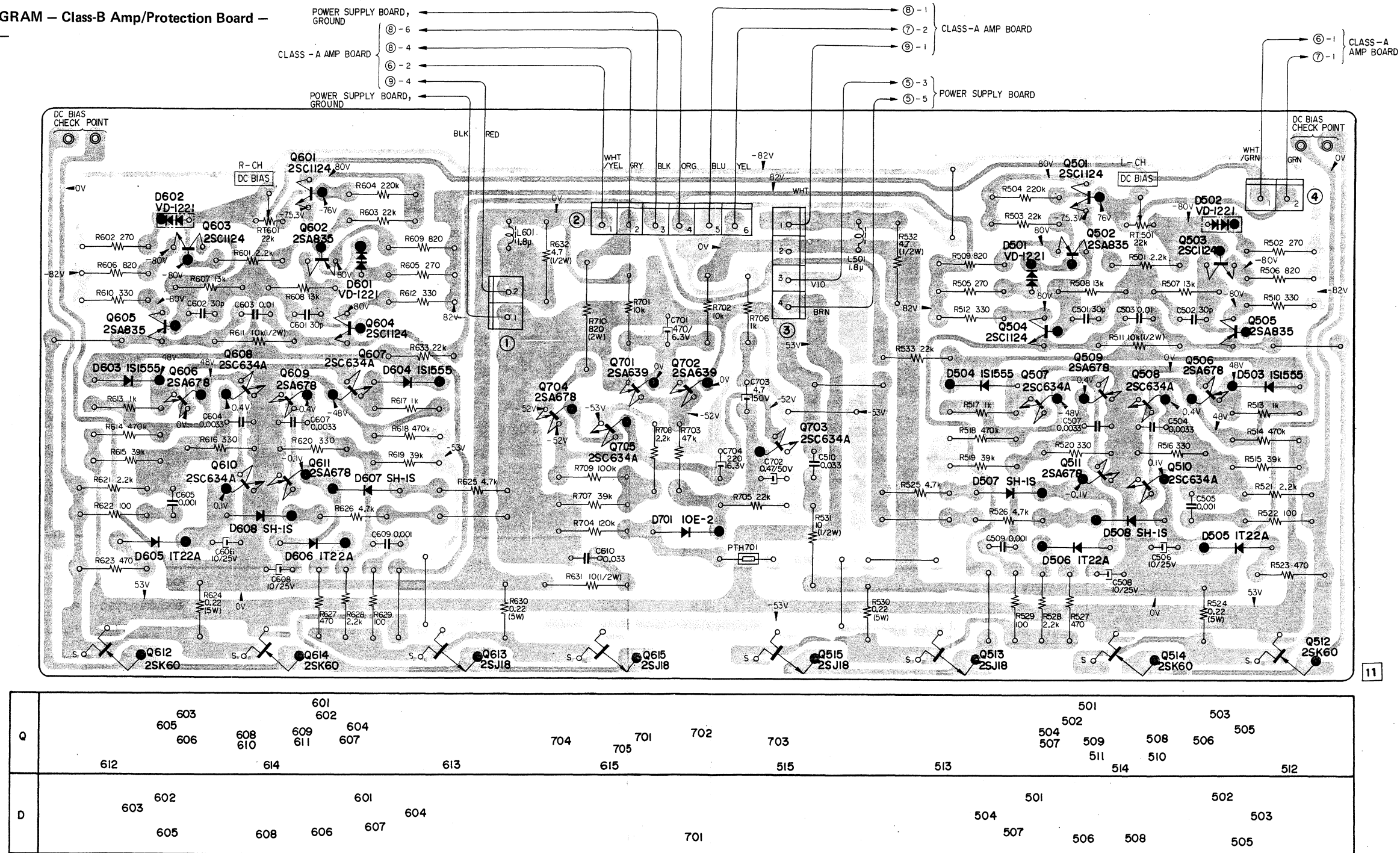

2SC634A

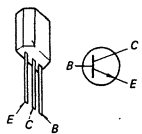

2SA678

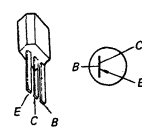

2SC1124

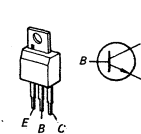

2SA835

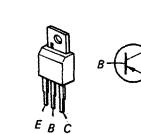

2SK60

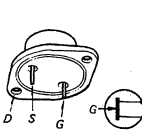

2SJ18

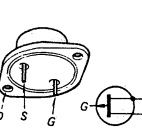

2SA639S

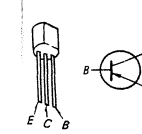

VD-1221

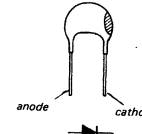

1T22A
1S1555
10E-2

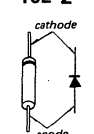

SH-1S

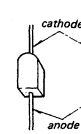

- Note:**
- All capacitors are in μF unless otherwise noted. 50 or less working volts are omitted except for electrolytic type. $p = \mu\text{F}$
 - All resistors are in Ω , $\frac{1}{2}\text{W}$, unless otherwise noted. $k = 1,000$
 - Voltages are DC with respect to ground unless otherwise noted. Readings are taken under no-signal conditions with a VOM (20 $k\Omega/V$).
 - B+ Pattern
 - B- Pattern
 - Voltage variations may be noted due to normal production tolerances.

TAN-555 TAN-5550

3-6. SCHEMATIC DIAGRAM

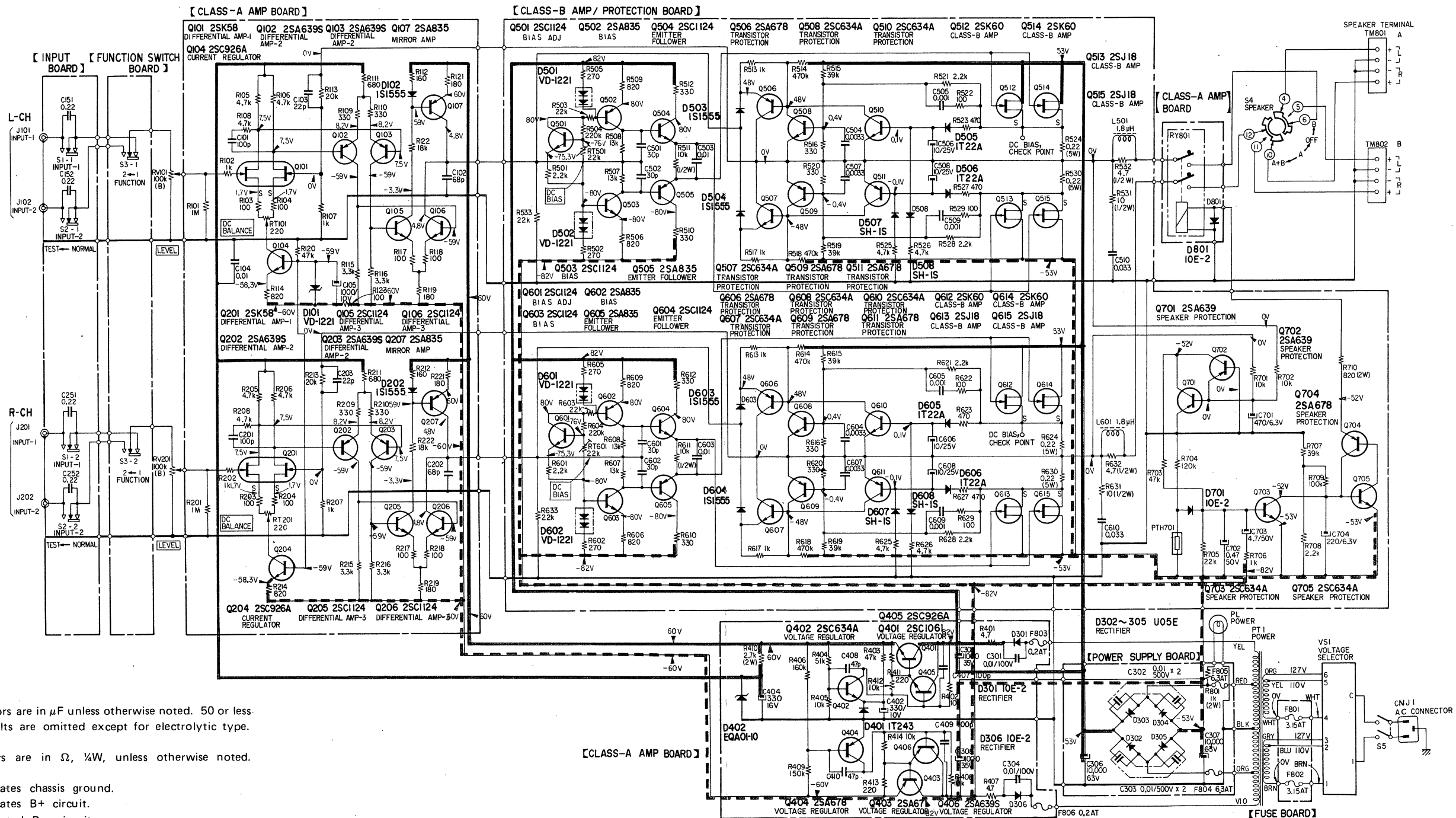

- Note:**
- All capacitors are in μF unless otherwise noted. 50 or less working volts are omitted except for electrolytic type. $p = \mu\text{F}$
 - All resistors are in Ω , $\frac{1}{2}W$, unless otherwise noted. $k=1,000$
 - --- indicates chassis ground.
 - --- indicates B+ circuit.
 - --- indicated B- circuit.
 - Voltages are DC with respect to ground unless otherwise noted. Readings are taken under no-signal conditions with a VOM (20 $k\Omega/V$). no mark: common
 - Voltage variations may be noted due to normal production tolerances.
 - Switch Mode:

SW. No.	NAME	POSITION
S1	INPUT-1	NORMAL
S2	INPUT-2	NORMAL
S3	FUNCTION	1
S4	SPEAKER	A
S5	POWER	OFF

SECTION 4
EXPLODED VIEWS

4-1.

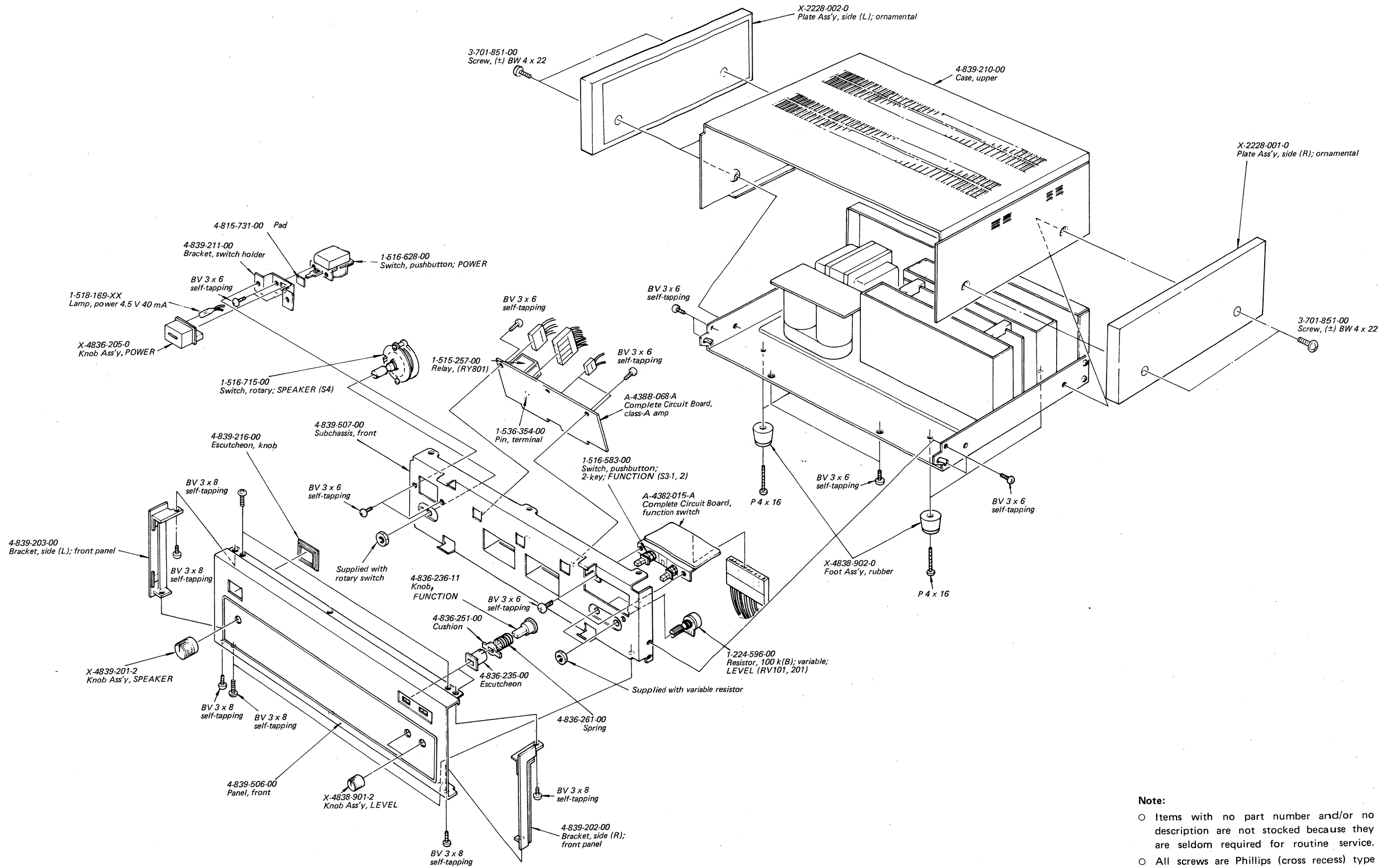

Note:

- Items with no part number and/or no description are not stocked because they are seldom required for routine service.
- All screws are Phillips (cross recess) type unless otherwise noted.
(-) = slotted head
- (□□T) shows the number of coils in spring.

TAN-5550 TAN-5550

4-2.

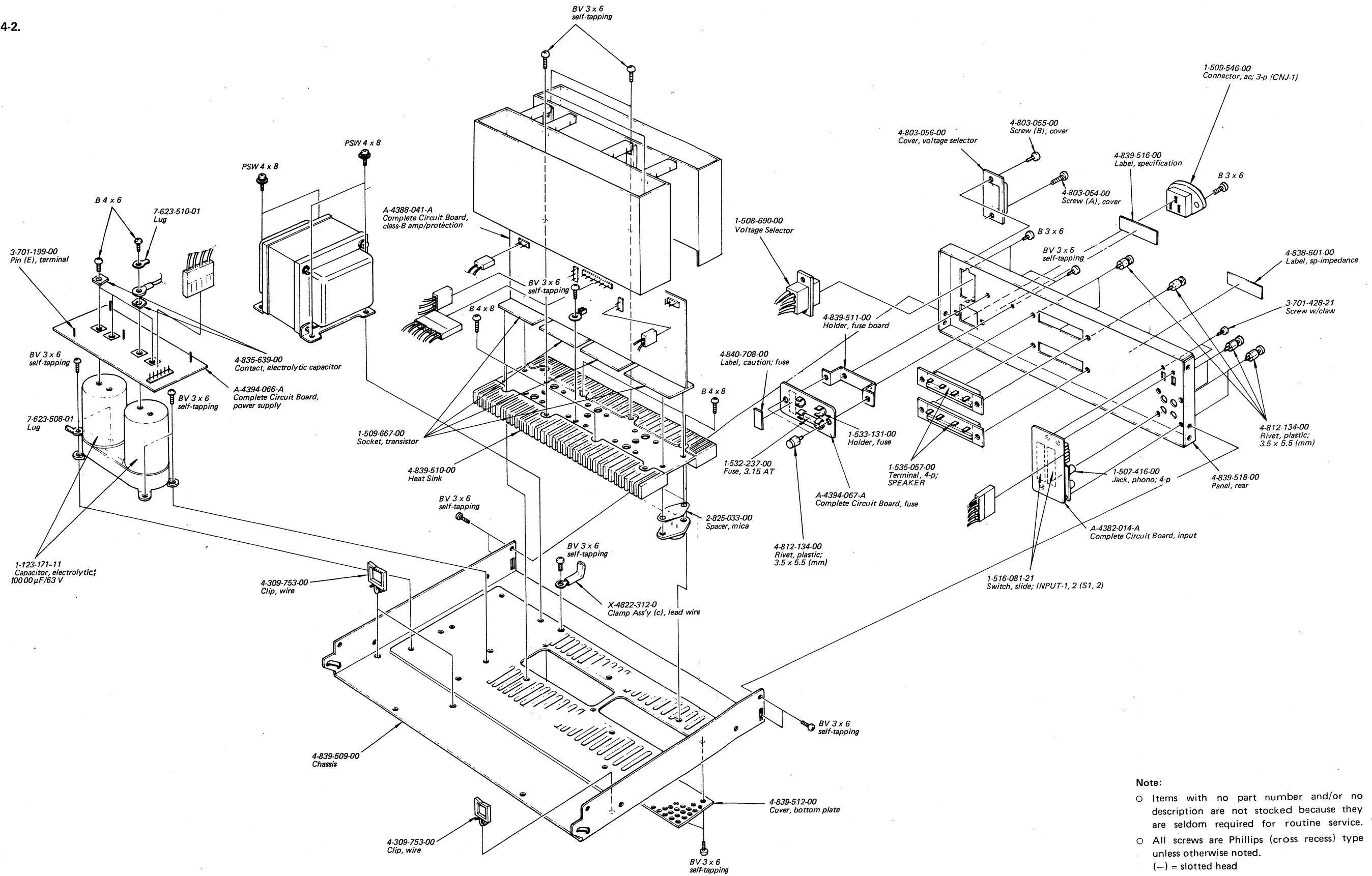

Note:

- Items with no part number and/or no description are not stocked because they are seldom required for routine service.
- All screws are Phillips (cross recess) type unless otherwise noted.
- (-) = slotted head
- (□□T) shows the number of coils in spring.

SECTION 5
PARTS LIST

5-1. ELECTRICAL PARTS

Ref. No.	Part No.	Description
COMPLETE CIRCUIT BOARD		
A-4382-014-A		Input
A-4382-015-A		Function Switch
A-4388-068-A		Class-A amplifier
A-4388-041-A		Class-B amplifier/protection
A-4394-066-A		Power supply
A-4394-067-A		Fuse
SEMICONDUCTORS		
Transistors		
Q101, 201		2SK58
Q102, 202		2SA639S
Q103, 203		2SC926A
Q104, 204		2SC1124
Q105, 205		2SA835
Q106, 206		2SC1124
Q107, 207		2SA835
Q401		2SC1061
Q402		2SC634A
Q403		2SA671
Q404		2SA678
Q405		2SC926A
Q406		2SA639S
Q501, 601		2SC1124
Q502, 602		2SA835
Q503, 603		2SC1124
Q504, 604		2SA835
Q505, 605		2SA835
Q506, 606		2SA678
Q507, 607		2SC634A
Q508, 608		2SA678
Q509, 609		2SC634A
Q510, 610		2SC634A
Q511, 611		2SA678
Q512, 612		2SK60
Q513, 613		2SJ18
Q514, 614		2SK60
Q515, 615		2SJ18
Q701, 702		2SA639

Ref. No.	Part No.	Description
Q703, 705		2SC634A
Q704		2SA678
Diodes		
D101		VD-1221
D102		1S1555
D202		1S1555
D301		10E-2
D302 ~ 305		U05E
D306		10E-2
D401		1T243
D402		EQA01-10
D501, 502		VD-1221
D503, 504		1S1555
D505, 506		1T22A
D507, 508		SH-1S
D601, 602		VD-1221
D603, 604		1S1555
D605, 606		1T22A
D607, 608		SH-1S
D701		10E-2
D801		10E-2
CAPACITORS		
All capacitors are in μF and electrolytic type unless otherwise indicated. 50 or less working volts are omitted except for electrolytic type. $p = \mu\mu\text{F}$		
C101, 201	1-102-973-11	100 p ceramic
C102, 202	1-101-888-11	68 p ceramic
C103, 203	1-102-959-11	22 p ceramic
C104	1-105-673-12	0.01 mylar
C105	1-121-943-11	1000 10 V
C151, 251	1-105-689-12	0.22 mylar
C152, 252		

Ref. No.	Part No.	Description
C301	1-105-713-12	0.01 100 V mylar
C302, 303	1-102-355-11	0.01 500 V ceramic
C304	1-105-713-12	0.01 100 V mylar
C305	1-121-388-11	1000 35 V
C306, 307	1-123-171-11	10000 63 V
C308	1-121-388-11	1000 35 V
C402	1-121-805-11	330 10 V
C404	1-121-521-11	330 16 V
C407, 409	1-102-973-11	100 p ceramic
C408, 410	1-102-880-11	47 p ceramic
C501, 601	1-102-962-11	30 p ceramic
C502, 602		
C503, 603	1-105-673-12	0.01 mylar
C504, 604	1-105-667-12	0.0033 mylar
C505, 605	1-105-661-12	0.001 mylar
C506, 606	1-121-398-11	10 25 V
C507, 607	1-105-667-12	0.0033 mylar
C508, 608	1-121-398-11	10 25 V
C509, 609	1-105-661-12	0.001 mylar
C510, 610	1-105-679-12	0.033 mylar
C701	1-121-419-11	470 6.3 V
C702	1-121-726-11	0.47 50 V
C703	1-121-396-11	4.7 50 V
C704	1-121-419-11	220 6.3 V
RESISTORS		
All resistors are in Ω . Regular-type $\frac{1}{4}$ W carbon and composition resistors are omitted. Check the schematic diagram for the resistance values. $k = 1,000$, $M = 1,000 k$		
R404	1-212-695-11	51 k $\frac{1}{4}$ W metal-oxide
R405	1-212-678-11	10 k $\frac{1}{4}$ W metal-oxide
R410	1-206-674-11	2.7 k 2 W metal-oxide
R511, 611	1-202-597-11	10 k $\frac{1}{2}$ W composition
R524, 624	1-217-156-11	0.22 5 W wirewound
R530, 630		
R531, 631	1-202-525-11	10 $\frac{1}{2}$ W composition
R532, 632	1-202-517-11	4.7 $\frac{1}{2}$ W composition
R710	1-206-662-11	820 2 W metal-oxide

Ref. No.	Part No.	Description
R801	1-206-662-11	1 k 2 W metal-oxide
RT101	1-224-550-00	220, adjustable
RT201		
RT501	1-224-491-00	22 k, adjustable
RT601		
RV101	1-224-596-00	100 k (B), variable; LEVEL
RV201		
SWITCHES		
S1, 2	1-516-081-21	Slide, INPUT-1, 2
S3-1, 2	1-516-583-00	Pushbutton, 2-key; FUNCTION
S4	1-516-715-00	Rotary, SPEAKER
S5	1-516-628-00	Pushbutton, POWER
FUSES		
F801, 802	1-532-237-00	3.15 AT
F803, 806	1-532-074-00	0.2 AT
F804, 805	1-532-325-00	6.3 AT
MISCELLANEOUS		
CNJ-1	1-509-546-00	Connector, ac; 3-p
J101, 201	1-507-416-00	Jack, phono; 4-p
J102, 202		
L501, 601	1-407-592-00	Microinductor, 1.8 μH
PL	1-518-169-XX	Lamp, pilot; 4.5 V 40 mA
PT1	1-442-537-00	Transformer, power
PTH701	1-800-340-00	Thermistor, positive
RY801	1-515-257-00	Relay
TM801	1-535-057-00	Terminal, 4-p; SPEAKER
TM802		
VS1	1-508-690-00	Voltage, selector
	1-508-648-00	Connector, male; 4-P
	1-508-649-00	Connector, male; 6-P
	1-508-650-00	Connector, male; 10-P

<u>Ref. No.</u>	<u>Part No.</u>	<u>Description</u>
	1-508-678-00	Connector, male; U-shaped
	1-508-684-00	Connector, male; 2-P
	1-508-692-00	Connector, male; 2-P
	1-508-748-00	Connector, female; 6-P
	1-509-667-00	Socket, transistor
	1-533-131-00	Holder, fuse
	1-536-354-00	Connector, male